



The Simpler | The Better

## Corded Stick Vacuum Cleaner User Manual

Model Number: I5 / I5s / I500 / I550 / I560 / I570

**EN**

**DE**

**IT**

**FR**

**ES**

## WARNING

**To reduce the risk of fire, electric shock or injury, please read all instructions before using**



1. This appliance is intended only for household use. Follow all user instructions in this manual.
2. Do not immerse any part of this appliance in water or other liquids.
3. This appliance can be used by children aged from 8 years old or above and individuals with reduced physical, sensory or mental capabilities or lack of experience and knowledge if they have been given supervision or instruction concerning use of the appliance in a safe way and understand the hazards involved.
4. Keep all part away from hot surface. Store indoors in a cool and dry place.
5. Do not run this appliance over any power cord.
6. Do not operate with a damaged power cord or plug, or if this appliance has been dropped/impacted and damaged.
7. To avoid the risk of electric shock, do not disassemble or attempt to repair this appliance. Contact the seller for a replacement if it is defective.
8. Close supervision is necessary for any part being used by or near children, pets or plants
9. Keep clothes, fingers, hair or any parts of human body away from any openings of the appliance or accessories while using.
10. Do not use to pick up flammable or combustible liquids such as gasoline or use in areas where they may be present.
11. Do not pick up anything that is burning or smoking such as cigarette butts, matches or hot ashes.
12. Do not use without the sponge inlet filter in place.
13. When pulling out the power plug from the electrical outlet, grasp the plug, not the cord.
14. Do not leave the appliance plugged in when unattended. Unplug the electrical cord when not in use and before servicing.
15. If the suction opening of this appliance is blocked, switch off and remove the blockages before you start the unit again.
16. Before you start vacuuming, make sure to remove large or sharp objects that might damage the sponge inlet filter.
17. Do not allow to be used as a toy.
18. Use only manufacturer's recommended accessories.
19. Do not pull power cord and, pull it around sharp edges or corners, se it as a handle or close a door on it. Do not run the appliance over power cord.
20. Turn off all controls as applicable before unplugging from electrical outlet.
21. Do not handle plug or vacuum with wet hands or operate without shoes.
22. Do not put any objects into openings. Do not use with any opening blocked. Keep free of dust, lint, hair and anything else that may reduce air flow.
23. Keep your work area well lit. Take extra care when cleaning on stairs.
24. Using improper voltage may result in damage to the motor and possible injury to the user. Correct voltage is listed on nameplate.
25. This appliance is provided with double insulation. Do not repair yourself to avoid electric shock. Please contact the seller to get original replacement parts.

## Product Specification

Dust Collection	Bagless	Power Cord	20ft
Power	600W	Use	Dry
Rated Voltage	AC220-240V 50/60Hz	Working Sound-Level	70 dB
Dust Cup	1 liter	Main Body Weight	3.85 lbs

## Product Components

1. Rotatable cleaner head
2. Retracted tube
3. Long crevice
4. 2-in-1 brush
5. Dust container release button
6. Power switch
7. Power cord
8. Dust release button
9. Accessories hook

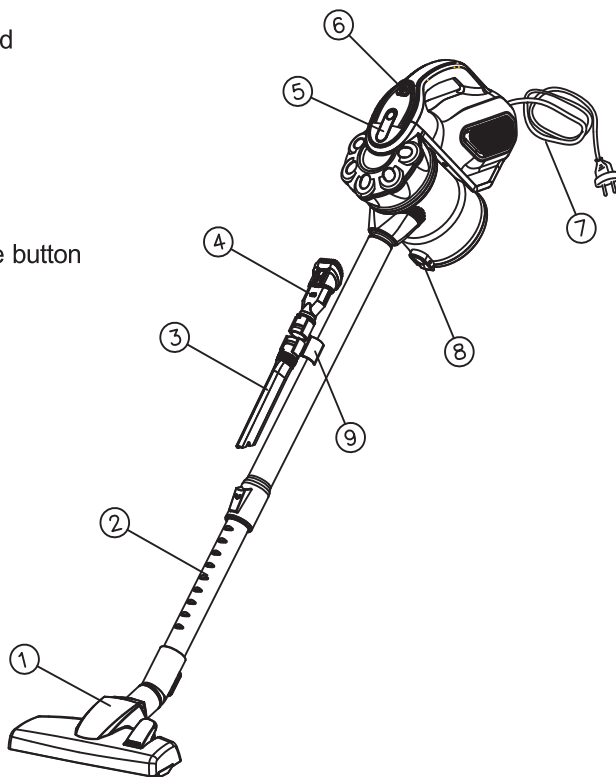

## Packing list:

Item Name	Quantity	Item Name	Quantity
Main Body (includes dust container with filter pad, motor and handle with power cord )	1	Retracted Tube	1
Cleaner Head	1	Long Crevice	1
2-in-1 Brush	1	Thank You Card	1
Accessories Hook	1	User Manual	1

## Operating Instruction

### Assembling the main body

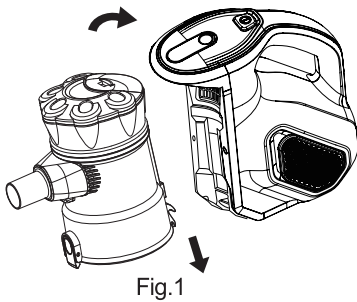

- Install the dust container by inserting its clip into the handle's slot, then hear a click to secure in place. (Fig.1)

- Push the retracted tube into the suction hole opening. (Fig.2)

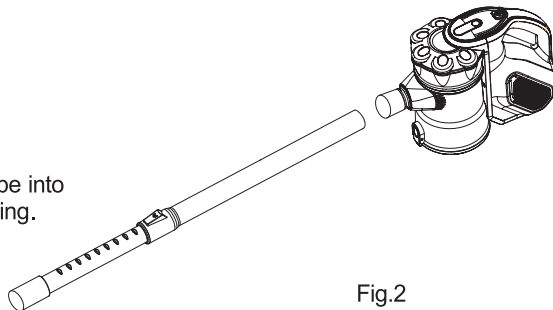

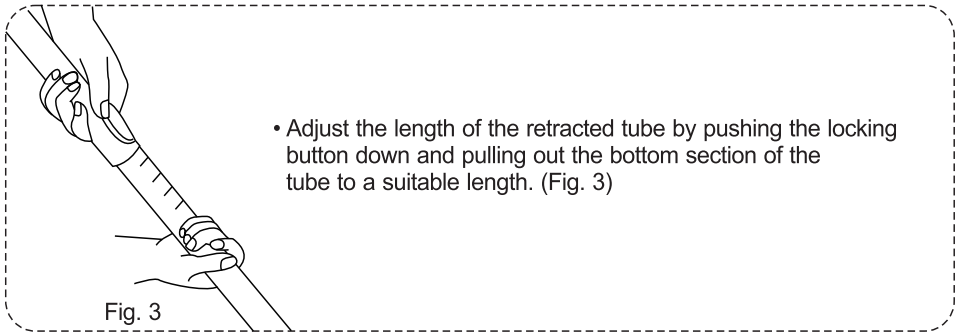

## Use the accessories

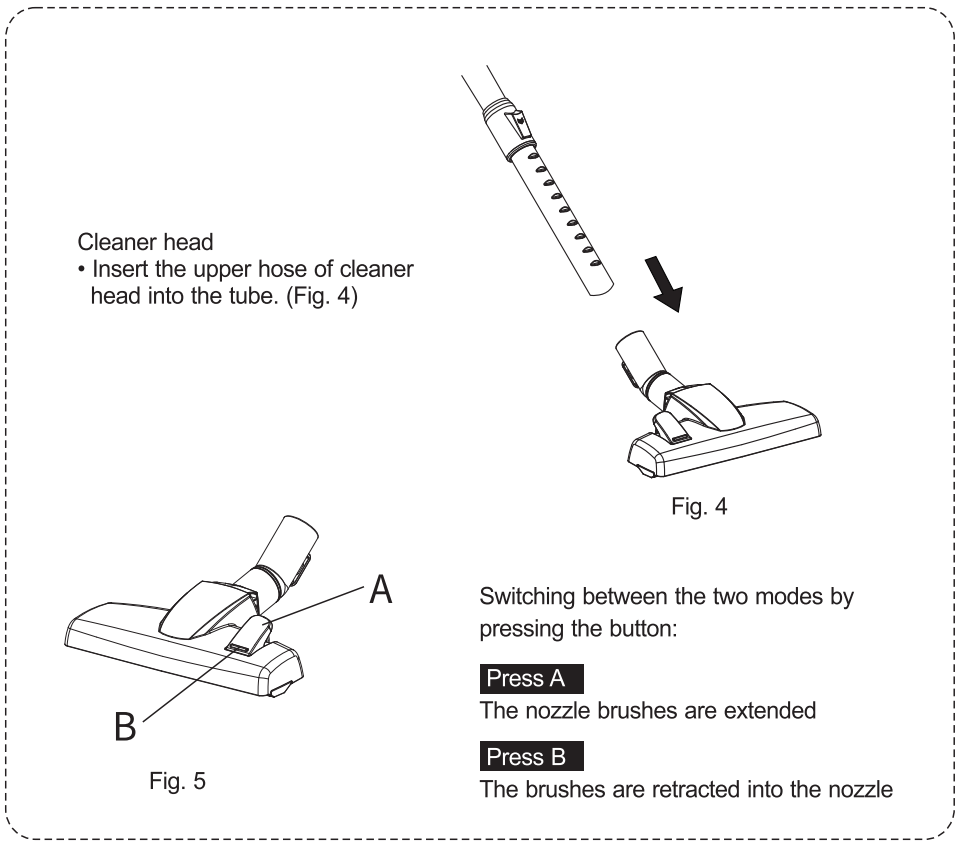

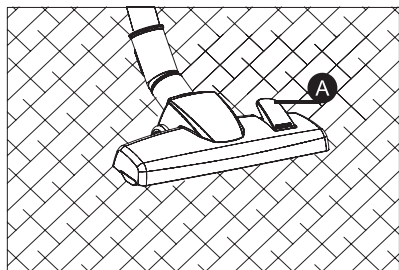

### **Brushless mode**

For carpet (Large Low-Medium Pile Carpet)

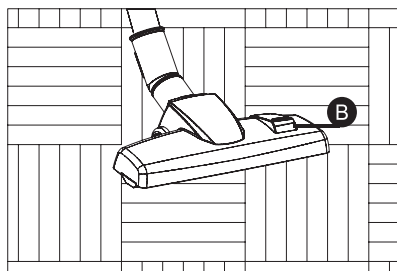

### **Brushed mode**

For Hard floor (Wooden&Marble&Tile )

### **Note:**

Due to powerful suction and high-power of all corded vacuums, the small or thin carpet would be easily sucked tightly by the vacuum cleaner and harder to clean.

### **Long crevice**

Recommend use for narrow space such as a gap, which makes your cleaning work faster and easier.

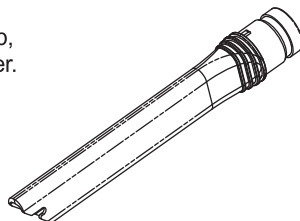

### **2-in-1 brush**

Recommend use for keyboard, curtain, dining-table etc.

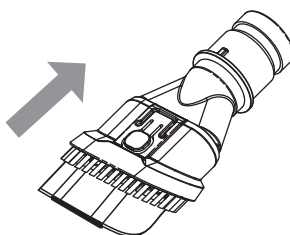
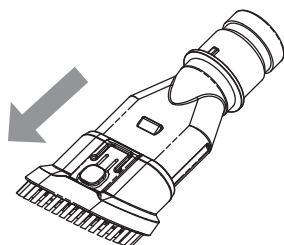

## Operating the vacuum

### 1. Insert the power plug into the electrical outlet.

**Tip:** please make sure power supply under correct voltage.

### 2. Turn on the appliance by pressing the power switch.

### 3. Start vacuuming, please keep the head brush touch the floor.

**Tip:** for high power devices, the temperature of the motor is higher than that of other parts during use, which is normal. Our product features overheat protection, so no need to worry.

### 4. Turn off the appliance by pressing the power switch again.

**Note:** Always remove the power plug from the electrical outlet before assembling or removing accessories.

## Maintaining Your Vacuum

### Cleaning the dust container

Press the dust container release button and detach the dust container from the handle part. (Fig. 6)

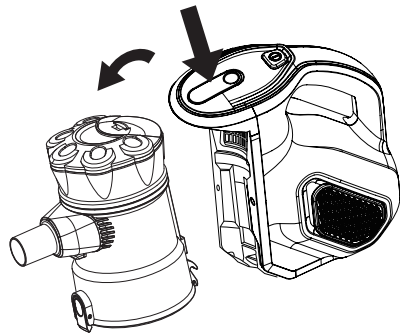

Fig.6

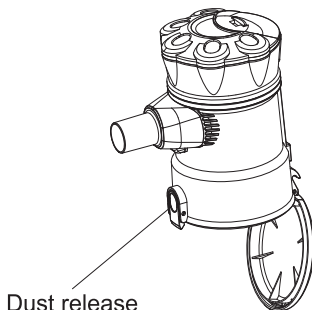

Fig.7

Open the button cover and expel any dust, dirt, and debris by pressing the dust release button on the waste bin. If further cleaning is needed, wash them with water only and let them air-dry completely. (Fig.7)

## Cleaning the sponge inlet filter

1. Detach the dust container from the handle part.
2. Twist the lid of the dust container anticlockwise to open.(Fig.8)
3. Remove the sponge inlet filter from the top of the dust container.(Fig.9)

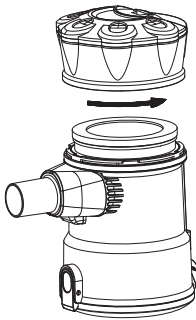

Fig.8

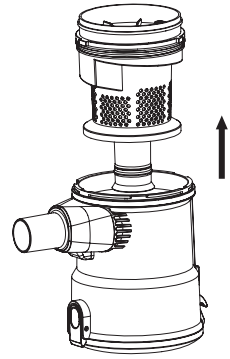
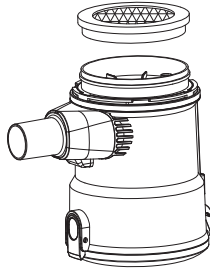

Fig.9

4. Rinse thoroughly under clean fresh water. Do not use soap or other detergents.
  5. Allow filter to dry naturally before placing back into the dust container.
  6. To reinstall the cover, line it up, then rotate down until it clicks into place.
- \* Do not place on radiators or use additional appliances, such as a hair dryer, to dry the filter. Doing so may cause warp or other irreparable damage to the filter.



## Checking for blockages

1. Remove the wand from the handheld vacuum and check all dust cup intake openings.

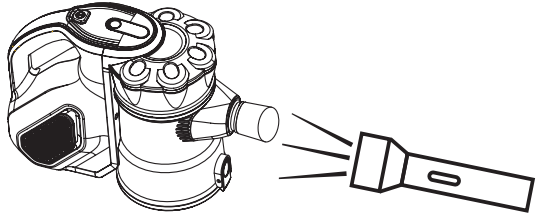

- 
2. Remove the floor nozzle from the wand and check the wand for blockages.

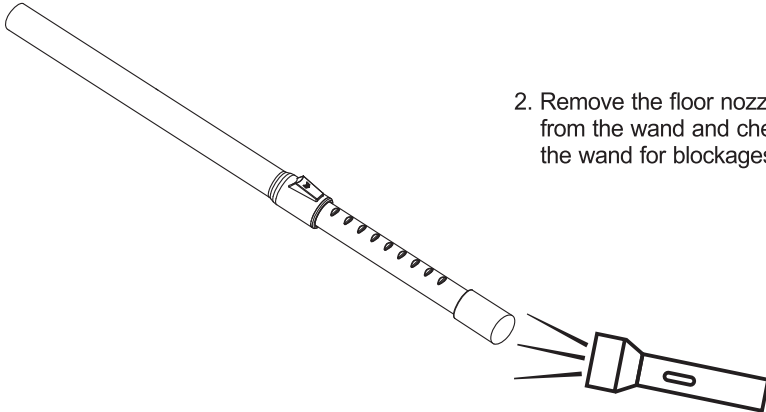

- 
3. Run scissors along the groove in the floor nozzle to cut or clear away any string, carpet fibers, hair, or other debris.

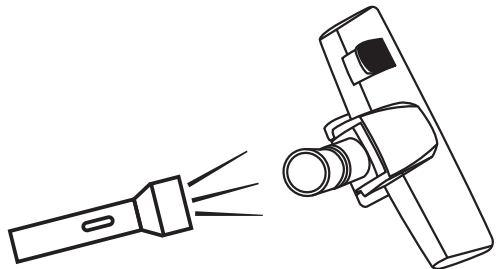
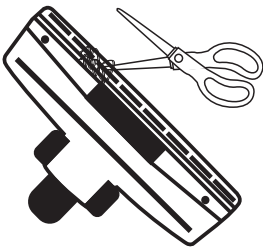

# Troubleshooting Guide



**Q: Appliance turns off on its own**

**A: Equipped with a motor-protective thermostat so it will shut off if it overheats**

1. Check for blockages in tube, accessories, and inlet connection.
2. Empty dust cup and clean filters (see Maintenance section).
3. Allow the unit to cool for a minimum of 30 minutes. Plug in vacuum and turn it on.



**Q: Doesn't pick up debris or weak suction**

**A1: The sponge inlet filter is filled with dust**

Remove sponge inlet filter, clean or replace it. Follow instructions for rinsing and completely air-drying the filters before reinserting in the vacuum.

**A2: Dust cup may be full, loose cover of dust box might cause reduced suction**

Empty dust cup, make sure the lid is closed and sealed completely.

**A3: Check floor nozzle for blockages**

Remove any string, carpet fibers, or hair that may be wrapped around the head brush.



**Q: Appliance doesn't work**

**A: No power in the electrical outlet or supply transformer**

Check fuse or breaker.  
Replace fuse/reset breaker.



**Q: Dust falls out from the inner tube**

**A1: Dust container is full**

Empty dust container.

**A2: Check for blockages in tube, accessories, and inlet connection**  
(see Maintenance section).



**Q: Dust comes out of the air outlet**

**A1: Sponge inlet filter is not installed correctly**

Install sponge inlet filter in place by following a corresponding instruction.

**A2: Sponge inlet filter is badly punctured or has a big hole**

Replace the sponge inlet filter.



EN

Please do not hesitate to contact us whenever you want, we are always

Contact Us By Scanning the QR Code Below:



 [help@inselife.com](mailto:help@inselife.com)

 [www.inselife.de](http://www.inselife.de)



MADE IN CHINA