

Robot Vacuum Cleaner

Robot vacuum-68/12



APP Download



Any after-sales problems,scan it!

Warm Tip

In order for you to have a smooth understanding of this robot please scan the QR Code with your mobile phone to get a video of the installation and operation of the product before use.

If you still have any other questions after watching the video, please feel free to contact us.

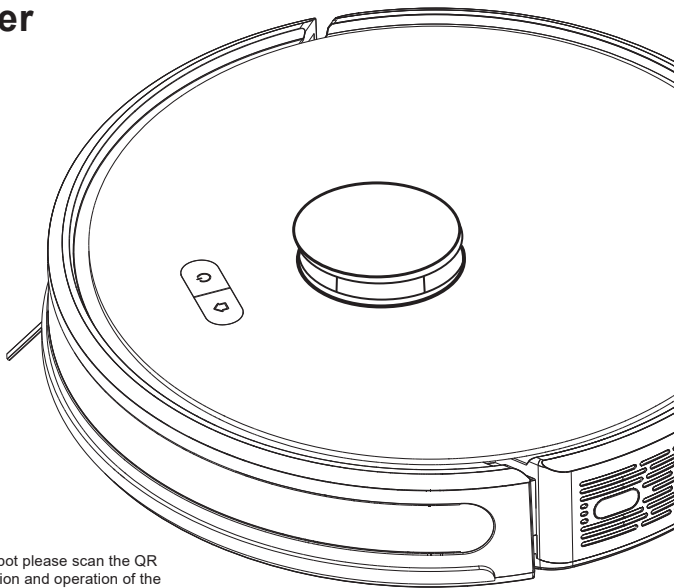

Table of Contents

Safety Warnings	01
Introduction	03
Installation and APP Connection	07
Use Instructions	14
Function Module	15
Maintenance	17
Malfunctions and Troubleshooting	21

Safety Warnings

Application Restrictions

- This machine is used for indoor cleaning only. Do not use the machine outdoors (such as open balcony), on non-floors (such as sofa) or in commercial or industrial places.
- Do not use the machine in the place of cliff without protective rails (such as duplex floors, open balcony, furniture top).
- Do not use the machine in the place more than 104°F or less than 32°F or on the ground with any liquids and viscous substances.
- Please hang up the wires on the ground indoors before use, to avoid the wires being entangled during cleaning.
- Please remove the fragile items and debris (such as vases, plastic bags, etc.) on the ground to avoid valuables being damaged due to obstacles or minor collisions.
- Those with physical, mental or perceptual impairments, including children, are prohibited to use or operate the machine.
- This machine should not be used as a toy by the children. Please keep children and pets away when the machine is working.
- Place the cleaning brush beyond the reach of the children.
- Do not place any objects (including children or pets) on the stationary or moving machine.
- Do not keep any parts of human body or pets such as hair and finger close to the suction port during the cleaning.
- Do not use the machine to clean the burning objects (such as unquenched cigarette butts)
- Do not use the machine to clean the plush carpet (some dark carpets may not be cleaned properly)
- Do not use the machine to clean the hard or sharp objects (such as decoration wastes, glass, iron nails, etc.)
- Do not use the bumper as the handle.
- Please cut off the power before cleaning or maintaining the machine or the charging base.
- Do not wipe any parts of the machine with a damp cloth or any liquid.
- Please strictly abide by the operation instructions. Any losses or injuries caused by improper operation shall be borne by the user.
- Do not activate the mop function on carpets or on top of furniture.
- Please remove the water tank during charging.

Safety Warnings

Battery and Charging

- Do not use the battery, charging base or charger produced by any third parties.
- Do not disassemble, repair or modify the battery or charging base without authorization.
- Do not keep the charging base close to heat sources (such as radiator).
- Do not wipe or clean the spring contacts of the charging base with a damp cloth or wet hands.
- Do not discard the used battery arbitrarily. The used battery should be handed over to professional recycling agency for proper disposal.
- Do not use the machine if the power cord is broken or wrecked, please buy new power cord through official channels.
- Please power off the machine during transportation. It's recommended to transport the machine with original package.
- If the machine will not be used for a long time, please power it off after being fully charged, then store in a cool and dry place. Charge the battery at least every three months to avoid the battery failure due to excessive discharging.

Introduction

Packing List

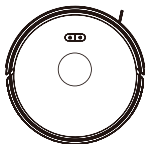

Machine

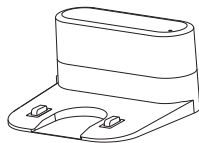

Charging Base

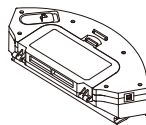

2-in-1 Dustbin & Water Tank

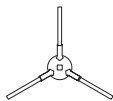

Side Brush

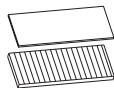

High-Efficiency filter+sponge

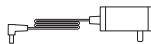

Adapter



Mop Holder



Mop



Cleaning Brush

Introduction

Machine

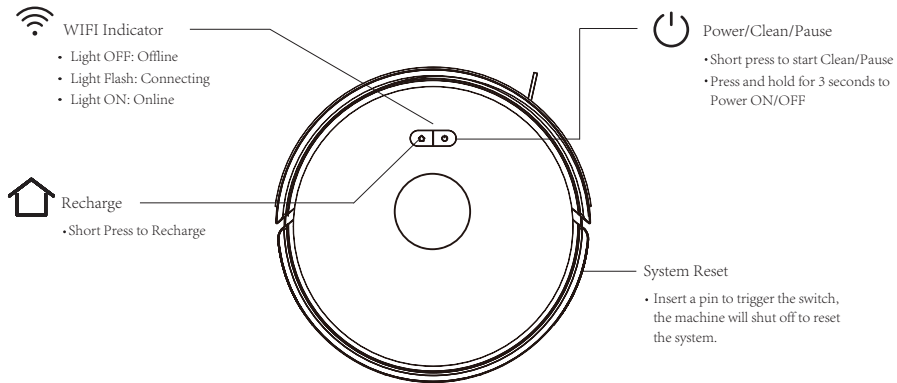

Introduction

Sensor and Structure

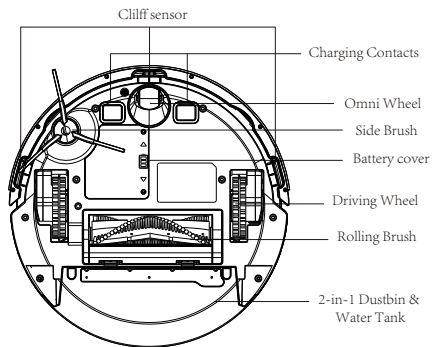
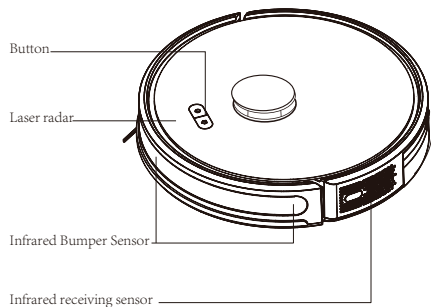

Introduction

2-in-1 Dustbin & Water Tank

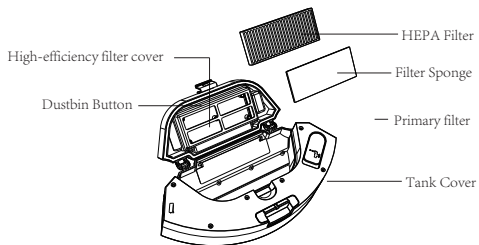

Charging Base

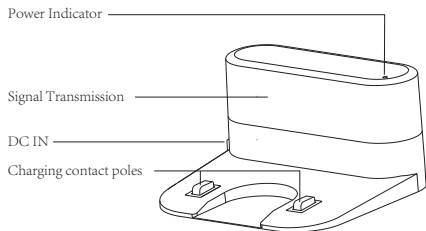

Installation and APP Connection

Notices

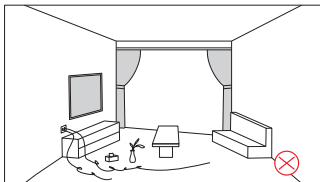

Please sort out the wires, debris and fragile, unstable, valuable and potentially dangerous objects on the ground before starting the device.

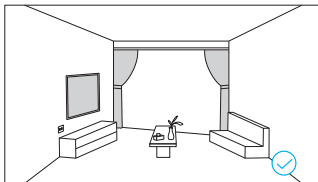

Avoid personal injury or property damage caused by entanglement, jamming, dragging, or bumping of equipment.

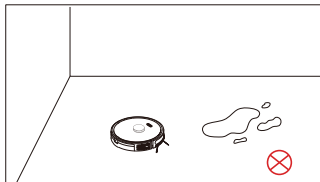

Do not use the robot to clean liquid.

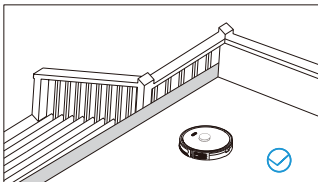

When used in a suspended circumstance, it shall be protected by rails to avoid accidental falling or pushing other articles from falling; otherwise, personal or property damage may be caused.

Installation and APP Connection

1. Remove the protective strips.

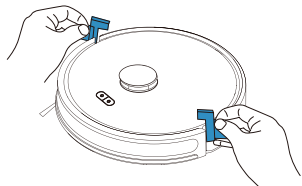

2. Install the side brush.

Align the side brush with the corresponding holes, press the side brush until you hear a click, indicating successful assembly.

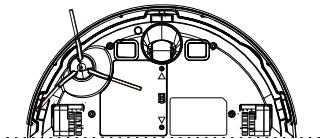

3. Connect the adapter to the charging base and arrange the power cable properly.

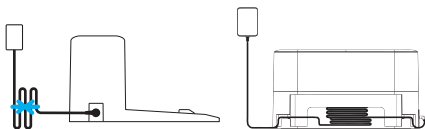

4. Place the charging base in proper position and power on for charging.

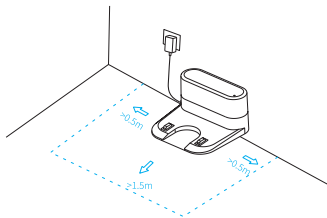

Notes:

1. Please place the charging base on a flat place against the wall.
2. Reserve a space of more than 0.5m on both sides and more than 1.5m in the front.
3. When the charging base is powered on, the charging indicator will be illuminated.

Installation and APP Connection

5. Do not move the charging base arbitrarily and keep it away from direct sunlight

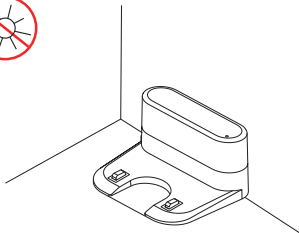

6. Power-On and Charging

Press and hold  to power on. When the indicator is illuminated, place the machine to the base for charging. The voice prompt of "Start Charging" indicates successful charging.

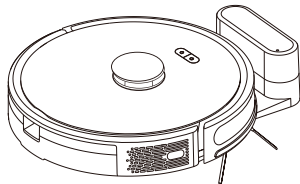

Note:

If the battery is too low to start the machine, please place the machine to the charging base and it will automatically power on.

Installation and APP Connection

Install Mopping Module

1. Add water into water tank: Open the tank cover, add an appropriate amount of water and then screw it tight. Do not add any cleaning agent.

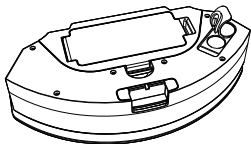

2. Install the 2-in-1 dustbin & water tank into the machine.

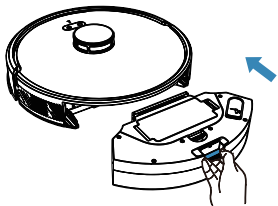

3. Install the mop to the holder.



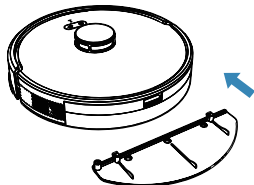

4. Install the holder to the bottom of 2-in-1 dustbin & water tank.



*Do not use the mopping function on the carpet, otherwise the carpet will get wet. Set Restricted Zone / Selected Zone to clean to avoid the carpet area.

Installation and APP Connection

Quick Connection

1. Activate the Bluetooth and make sure your phone is connected with the 2.4 GHz WiFi that usually only shows the name of the WiFi.
Please don't connect the 5GHz WiFi with your phone.
2. Download and install the APP: Search the "smart life" in Appstore/Google Play or scan the QR code to download it.
3. Open the "smart life" App, agree to the "User Agreement and Privacy Policy" and register your account.
4. Turn on the robot vacuum, then press the "  " and the "  " button meantime for at least 3 seconds until the WiFi button flashes.

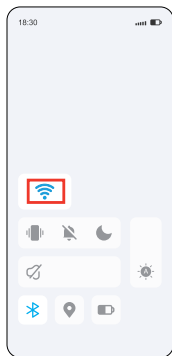

①

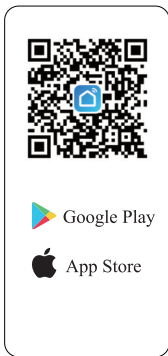

②

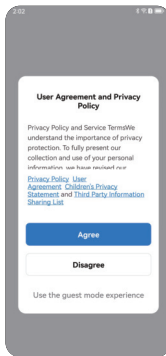

③

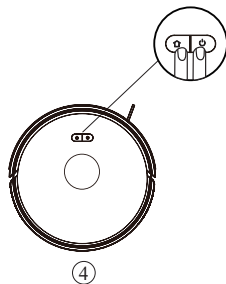
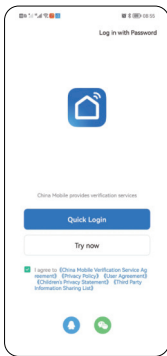

Installation and APP Connection

Quick Connection

5.Add your device: Open the"smart life "APP and click "Add" Device" to add your robot vacuum.

6.Discovering Devices: Allow "smart life"APP to get the related permissions,then click 'Add' (it usually needs to take 8-10 seconds.)

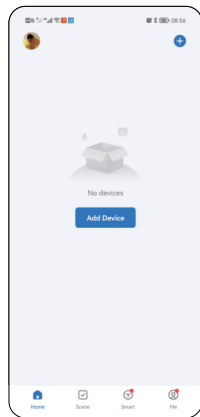

5

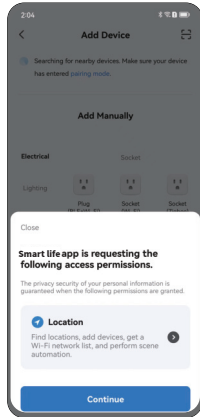

6

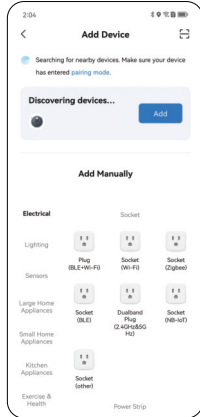
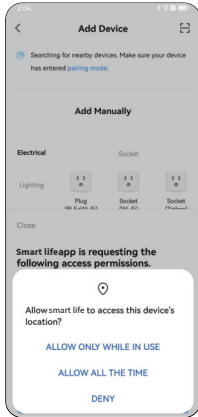

Installation and APP Connection

Quick Connection

7. Enter the WiFi password and click the "next"

8. Wait for auto-connecting. It needs to take 1-2 minutes.

9. Click "Done" and log in to the App operation page.

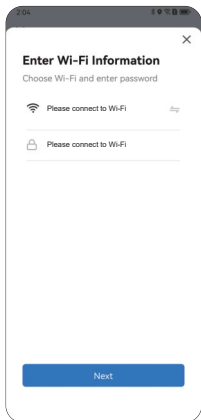

7

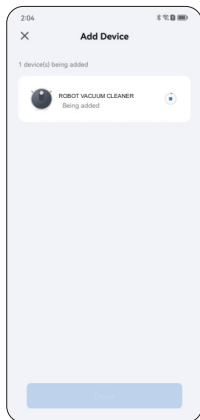

8

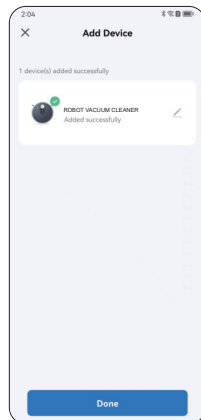

9

Installation and APP Connection

Slow Connection

1. Activate the WiFi in phone to connect to 2.4GHz network.

2. Download App: Search "Smart Life" in Appstore or scan the QR code.

3. Registration: Open the APP and complete the registration.

4. Log in the APP and click "Add Device"/+ Button

5. Choose "Small Home Appliances" – Robot Vacuum (Wi-Fi)

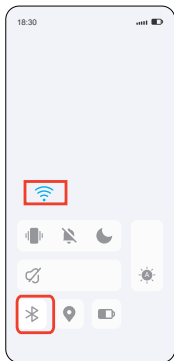

①

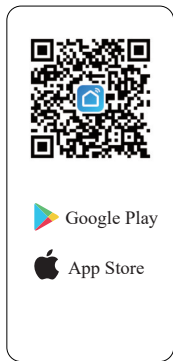

②

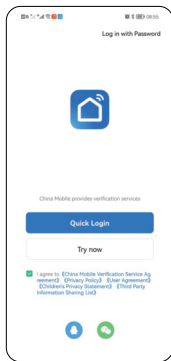

③

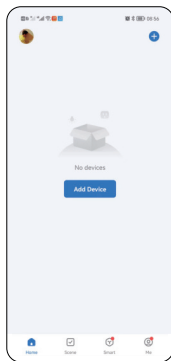

④

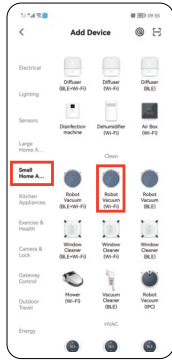

⑤

Installation and APP Connection

Slow Connection

6. Enter the password and click "Next".

7. Press both "Power + Charge" buttons for 3 seconds and the light starts to flash, which means the machine starts network distribution.

8. Click "Confirm the Indicator is Blinking" button.

9. Select the AP mode.

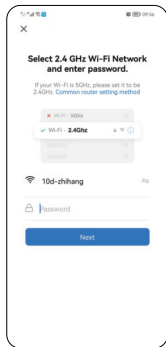

6

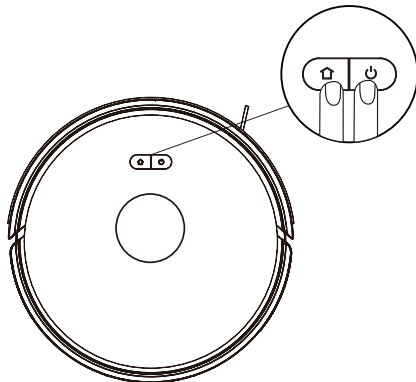

7

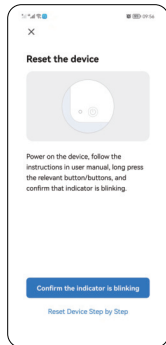

8

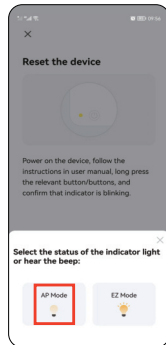

9

Installation and APP Connection

Slow Connecton

10. Click "Next".

11. Then select SMATR LIFE XXX and return.

12. Wait for the connection.

13. Click "Done" to log in APP.

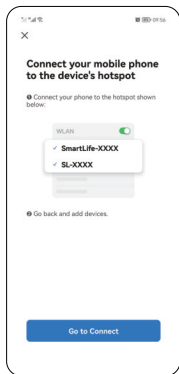

10

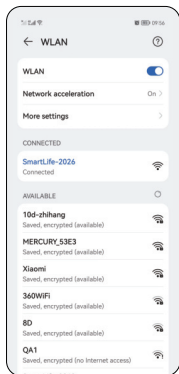

11

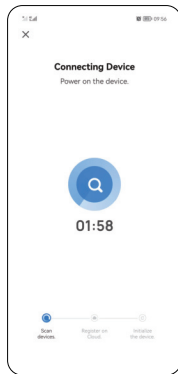

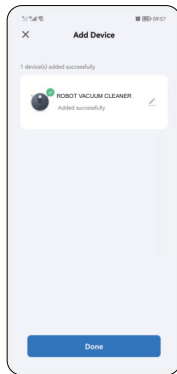

12



13

Use Instructions

Power ON/OFF

Press and hold  for 3 seconds till the indicator is illuminated, which means the machine has been powered on. Press and hold  for 3 seconds in standby mode, the indicator is OFF, which means the machine has been powered off. Note: The machine cannot be powered off during the charging.

Clean/Pause

After the machine is powered on, short press  or APP to start cleaning.

Charging

Auto Mode: The machine will automatically return to the charging base for charging after cleaning.

Manual Mode: In the PAUSE state, short press  to start the recharging or APP to start the recharging.

Note: If the machine cannot find the charging base, it will automatically return to the starting position, please place the machine back to the charging base manually.

Notes:

- Do not clean the liquid.
- The machine cannot start cleaning if the battery is lower than 15%, please charge the machine first.
- If the battery is lower than 15% during the cleaning, the machine will automatically return to the base for charging.
- Please clear up the wires on the ground (including the power cord of charging base) before cleaning to avoid power failure or property damages due to cable entanglement during cleaning.

Function Module

Smart Clean (Default)

1. Before the first use, Robot Vacuum will scan the domestic environment first and generate a map with smart area divisions.

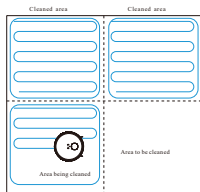

2. Based on the existing area divisions, Robot Vacuum will clean along the edges to form a closed area first and fill in the area in a Z-shaped manner, then clean the remaining areas one after one.
3. After cleaning, Robot Vacuum will return to the base for recharging.

Note:

- To generate the map better, it's recommended to start from the charging base before the first use.
- When the machine is working, do not move it arbitrarily, otherwise it may start repositioning; if the repositioning fails, the machine will abandon the previous task and may not return for recharging.

Targeted Clean

1. Select " Press to run" in the APP.
2. Select a point to be cleaned on the map, then click  "Go Here" to start the clean.

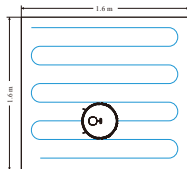

3. Robot Vacuum will move to the designated location and clean an area of 1.6m×1.6m square with itself as the center twice, then return the charging base for recharging.

Note: The map needs to be generated in the APP before use

Function Module

Designated Clean

1. Select the cleaning function for the selected area in the APP.
2. Select the area to be cleaned on the map and click "Select Room"
3. Robot Vacuum will clean the designated area.

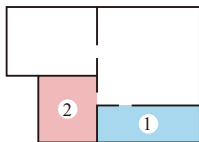

Note:

- Please clear the obstacles around the designated area to ensure the machine can access.
- The map needs to be generated in the APP before use.

Customized Clean

Select "Area Sweep" in the APP and click "+ cleaning area" in the right. Select an area to be cleaned on the map and click "Go Here" Robot Vacuum will start the clean within the customized area.

Note:

- Please clear the obstacles around the designated area to ensure the machine can access.
- The map needs to be generated in the APP before use.

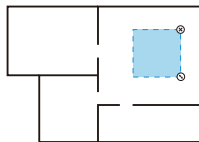

Customized Clean

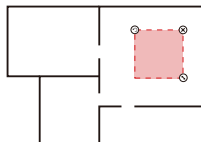

Restricted Area Setting

Restricted Area Setting

Select "Forbidden Edit" in the APP and set the restricted area on the map (+, Mop & sweep or + Mop forbid area), then save the settings and the machine will not access to the set area for cleaning.

Note:

- The map needs to be generated in the APP before use.
- The selected restricted area should not be too close to the charging base.
- When Robot Vacuum is moved or the domestic environment has significantly changed, the map may become invalid and the restricted area may get lost

Maintenance

It's recommended to clean the rolling brush every 1~2 weeks.

1. Turn the machine over and press the buckle to remove the brush lid.
2. Remove the rolling brush.

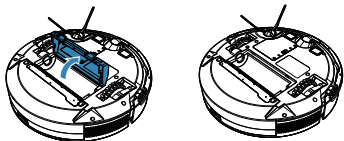

3. Clean the main brush and rolling brush with the tool provided and remove the entangled debris on the rolling brush.

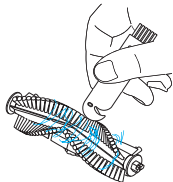

Side brush (to be cleaned every week)

1. Turn the machine over and pull out the side brush vertically.
2. Remove the entangled hairs and dirt, then reinstall the side brush.
3. Press the brush into the corresponding hole to complete the brush installation.

Note: It is recommended to replace the side brush every 3~6 months (especially when the side brush is seriously deformed) for the sake of satisfactory cleaning effect.

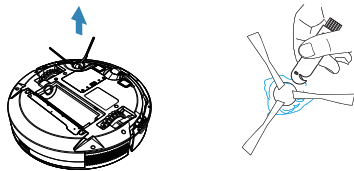

Maintenance

Dustbin and Filter (to be cleaned every 2~3 days)

1. Press and hold the button to pull out the dustbin.

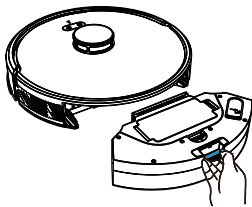

2. Press and hold the dustbin lock to open and dump the dirt inside.

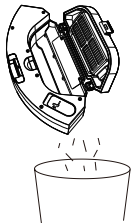

Clean the dustbin (to be cleaned every week)

1. Clean the filter: Remove the filter sponge and HEPA filter. Gently tap the HEPA filter to remove the dust.
2. Clean the dustbin: Open the dustbin and clean with a brush or rag.



3. If the dustbin is too dirty, it can be washed with water. Please use only after being thoroughly dried.

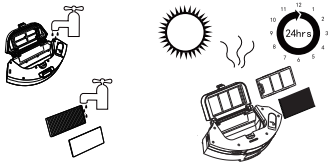

Notes:

1. Please do not add detergent when washing the dustbin with water; make it thoroughly dry after wash.
2. It is recommended to replace the HEPA filter every 3~6 months

Maintenance

Clean the infrared bumper sensor (to be cleaned every month)

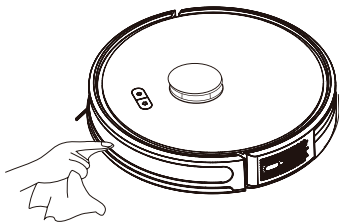

Clean the edge sensor (to be cleaned every month)

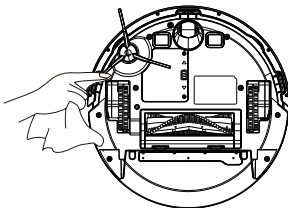

Clean the charging contacts (to be cleaned every month)

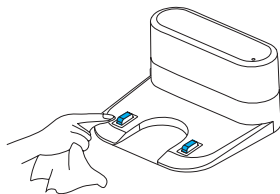
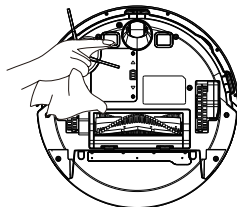

Maintenance

Clean the signal transmitting area (to be cleaned every month)

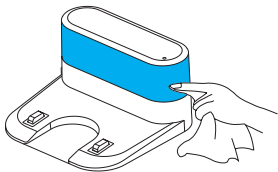

Battery

- The machine is equipped with high-performance rechargeable lithium-ion battery. For the sake of battery performance, please keep the machine fully charged in daily maintenance.
- If the machine will not be used for a long time, please power it off before storage and charge the battery at least every three months to avoid battery failure.

Firmware Upgrading

The firmware can be upgraded through the APP when new firmware is detected. Please follow the instructions to complete the upgrading. More than half battery may be needed for the upgrading, it's recommended to complete the firmware upgrading on the charging base.

Malfunctions and Troubleshooting

Descriptions	Machine cannot be switched on
Machine cannot be switched on.	<ul style="list-style-type: none"> • The battery is low, please place the machine to the spring contact of the charging base and the machine will automatically power on. • Ambient temperature is less than 32°F for more than 104°F, please use the machine in the 32°F~ 104°F environment.
Machine cannot be charged.	<ul style="list-style-type: none"> • Please remove the machine and confirm whether the indicator of the charging base is illuminated, whether the charging base and the adapter have been plugged into the socket. • Poor contact, please clean the spring contacts of the charging base and the machine, or move the edge brush aside.
Machine cannot return to charging base.	<ul style="list-style-type: none"> • The machine is too far away from the charging base, please place the machine near and try again. • Many obstacles on the way back to the charging base.
Abnormal behaviors	Please power off and restart the machine.
Strange noises when cleaning.	The main brush, side brush or wheel may be entangled with foreign objects, please clean up after power off.
Reduced cleaning ability or ashes out of the machine	<ul style="list-style-type: none"> • The dustbin is full, please clean the dustbin. • The filter has been blocked, please clean or replace the filter. • The rolling brush is entangled with foreign objects, please clean up the rolling brush. • The ground is too dirty, please increase the suction force.
Failed WIFI connection	<ul style="list-style-type: none"> • WIFI signal is weak, please confirm the machine is covered by strong WIFI signal. • Wrong WIFI connection, please reset WIFI, download the latest phone client and try again. • Wrong password. • This machine only supports 2.4GHz WIFI band.
Appointment cleaning cannot be activated.	The battery is low, the appointment cleaning cannot be activated unless the remaining battery is higher than 15%.

Malfunctions and Troubleshooting

Voice Prompt	Solutions
Insert dustbin	The voice prompt will be heard when the dustbin is removed. Please insert the dustbin.
Put the vacuum on the floor before starting	Please pick up the machine; if the machine is not fully contact the ground, please move the machine to a flat place and start again.
Put the machine flat on the ground before starting	The machine is tilted, please move the machine to a flat place and start again
Front bumper is stuck	The edge or bumper sensor is stuck, please gently push the bumper to eliminate any possible blockages.
Battery is low, going to recharge	Place the machine on the charging base for charging.
The vacuum is stuck	Please move the machine to an open place and start it again.
Wheels are stuck	The main wheel is stuck or entangled, please check the main wheel and remove the foreign objects.
Main brush is stuck	The rolling brush is entangled or stuck, please check the rolling brush and remove the foreign objects.
Side brush is stuck	The side brush is entangled or stuck, please check the side brush and remove the foreign objects.

***The robot vacuum contains five languages**

English (default), German, French, Italian, Spanish, according to your own needs, choose the language for voice broadcast through the APP "SMART LIFE". "Setting"- "Voice and volume"

SIMPLIFIED EU DECLARATION OF CONFORMITY

Hereby, Shenzhen XinCheng Innovation Technology Co.,ltd declares that the radio equipment type Robot Vacuum Cleaner is in compliance with Directive 2014/53/EU. The full text of the EU Declaration of Conformity is available at the following internet address
<https://files.innpro.pl/Lubluelu>

Manufacturer's address: ShenzhenShi LongGangQu, BanTianJieDao, MaAnTangSheQu,
HuanChengNanLu 17 Hao, HengDa DuHui Guang Chang 1 Dong 2809

Radio frequency:

Maximum radio frequency power:

Customer Service

Please contact us if you need any help as following:

- Technical Support
- Package is NOT in perfect condition
- Parts missing
- Any other quality issues

If the above problem occurs look at the bottom of the robot



CET PRODUCT SERVICE SP. Z O.O.
33 Długa Street, Apt. 102 Zgierz Łódzkie PL(Poland)
Email: info@cetproduct.com



GSG CONSULTING GROUP LIMITED
Montague houses unit 3 Matthew street Manchester m12 5bb
Email: GSG--GROUP@outlook.com



MADE IN CHINA