

deerma

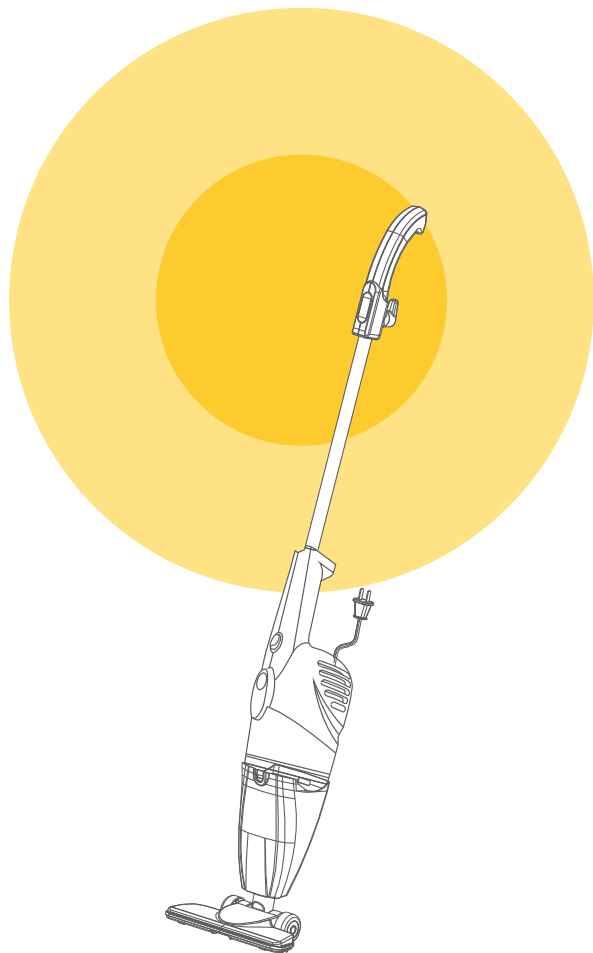

Deerma Vacuum Cleaner

Continuous large suction can take away the dust

It is great at picking up fine dust rapidly and flexibly for each corner.
It is effective storing the dust not backflow to give you a clean living area.

DX118C

Product Structure Diagram

1. Handle
2. Power cord hook
3. Metal tube
4. Power cord
5. Power switch

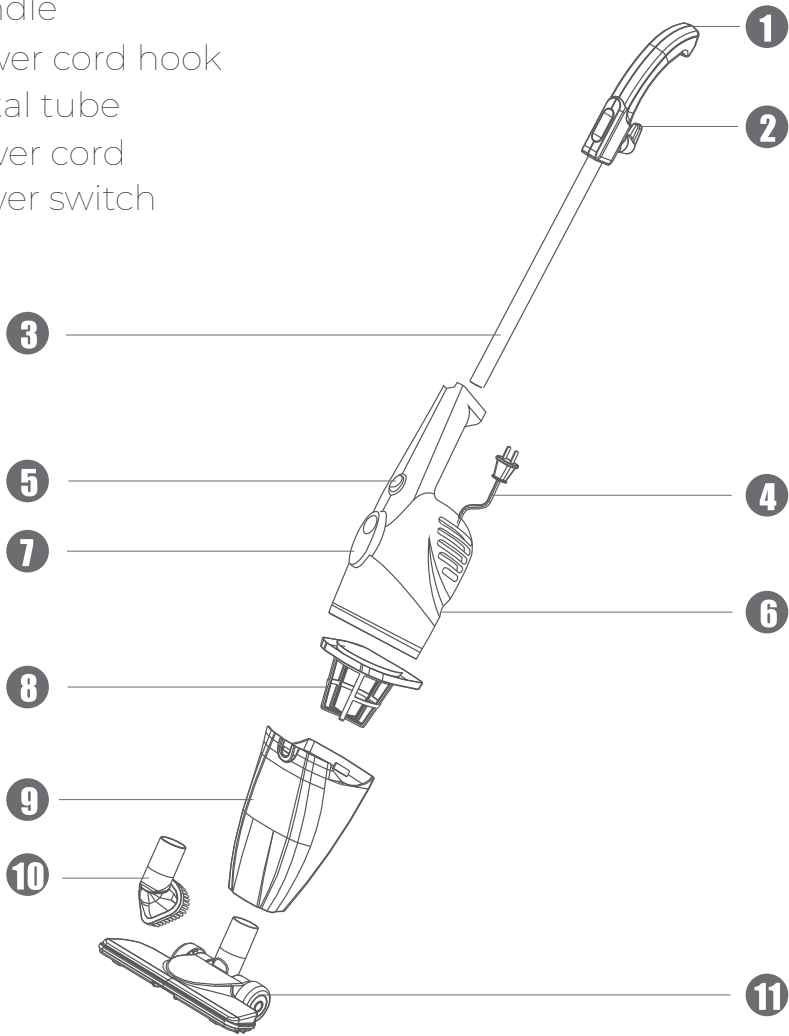

6. Machine Body
7. Dust Panel frame switch
8. Trainer
9. Dust panel frame
10. Round brush
11. Ground brush

Precautions

1. Vacuum cleaner is an electric appliance, it must be used in accordance with the conditions of the specification, the specification must be properly preserved for future reference.
2. Check and confirm that the vacuum cleaner uses voltage must be consistent with the power supply voltage.
3. Do not inhale the following objects, or may damage the vacuum cleaner or cause a fire, resulting in personal injury and other accidents.
 - A. heating objects, such as carbon fire, etc.;
 - B. cut sharp fragments, such as glass, etc.;
 - C. harmful objects or water and liquids (solvents, corrosive agents, etc.)
 - D. flammable and explosive substances, such as gasoline or alcohol products
4. To clean, repair or temporarily do not use vacuum cleaner, must be cut off the power supply. When cutting off the power supply is not allow to pull the power line, should be hand up the plastic part of the plug pull it out.
5. Avoid the vacuum cleaner be immersed in water, avoid closing to heating equipment or exposure, so as to avoid fire.
6. Don't let the children play with the vacuum cleaner, so as to avoid accident.

7. Please do not use the vacuum cleaner in the following situations:

- A. fall and appear obviously damaged or running is not normal;
- B. power cord breakage.

In above case, do not starting the machine, in a timely hand it over to our company designated maintenance Department to repair.

8. Avoid long running in the state of the suction mouth blocking, so as to avoid motor damage and vacuum cleaner heating deformation.

9. This product power line and motor using Y type connection, if the power line is damaged, must use the special equipment to be replaced, or send it to the professional maintenance department.

Circuit Diagram

This diagram is for reference only. No further notice will be issued in case of any change. The product is subject to the real object, and our company reserves all the right for final interpretation.

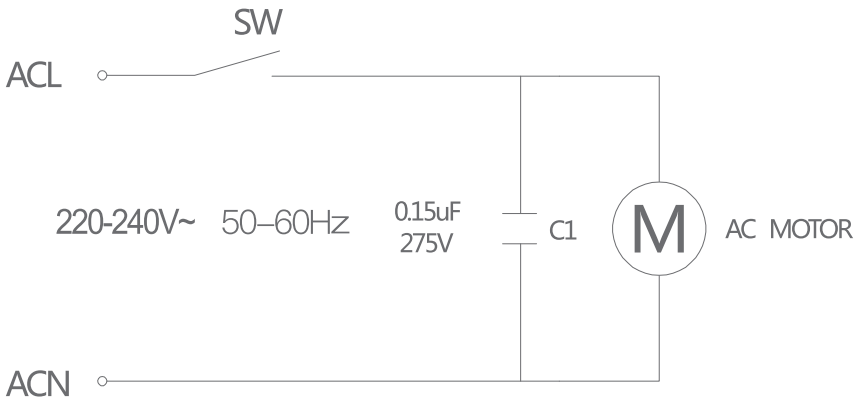

Application Method

Handle Push Use:

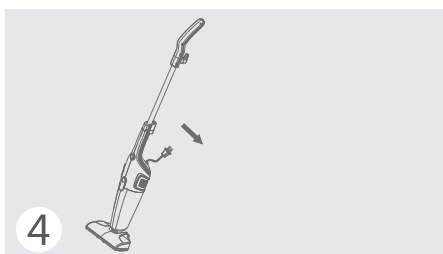
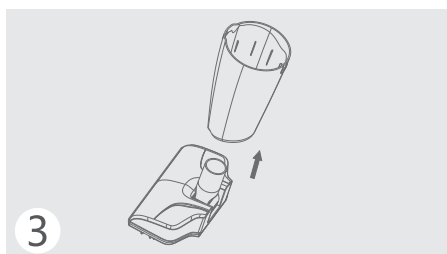
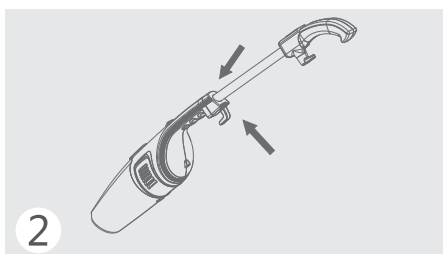
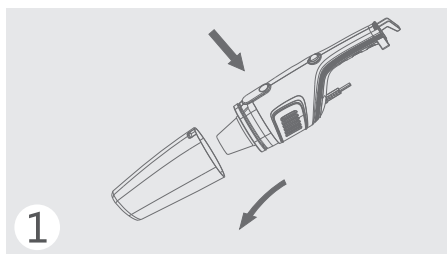

1. Press the dust panel frame switch to open the dust panel frame before use, confirm that the dust panel frame is equipped with the strainers, and then reassemble the dust panel frame. Check that the parts of the body are firmly connected, and set the power switch to „O” (off) gear.

2. Open the buckle at the back of the main machine handle, align the metal tube with the hole in the middle of the handle, insert the metal tube straightly into the bottom, and then clamp the buckle on the handle to the fixed block on the metal tube handle assembly.

3. The ground brush is facing the direction of the power switch of the machine body. Insert the ground brush into the suction inlet and confirm that the connection is secure.

4. Insert the power plug into the socket and confirm that the connection is secure. Put the power switch of the machine body to „I” (ON) gear and the vacuum cleaner starts working.

5. Set the power switch to „O” (OFF) gear, and remove the plug from the socket.

6. Wind the power cord onto the two power cord hooks and place the cleaner upright in the storage area.

Handle Lift Use:

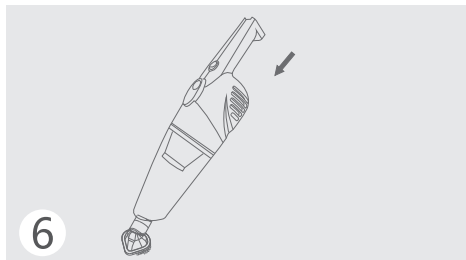
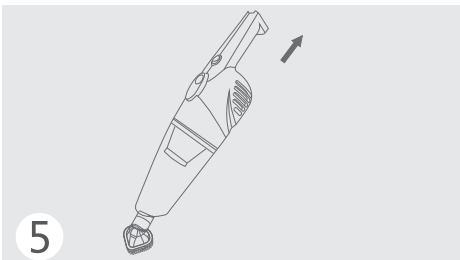
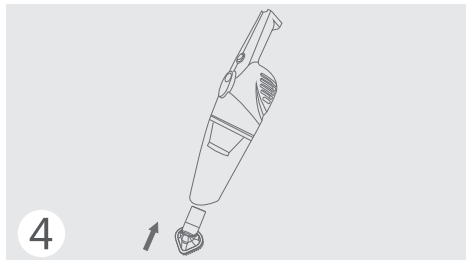
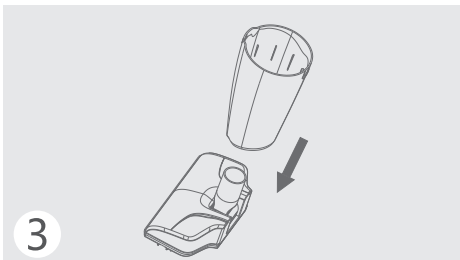
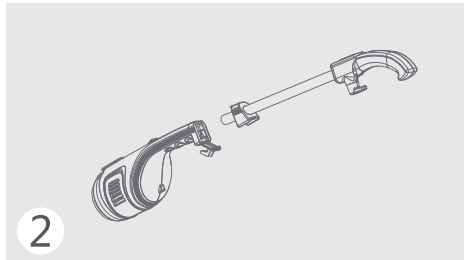
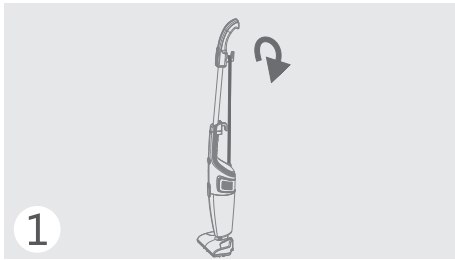

1. Rotate the power cord hooks on the handle to release the power cord quickly.

2. After open the buckle from the fixing block on the metal tube, pull out the metal handle as a whole, and then clamp the buckle to the corresponding position of the main machine handle.

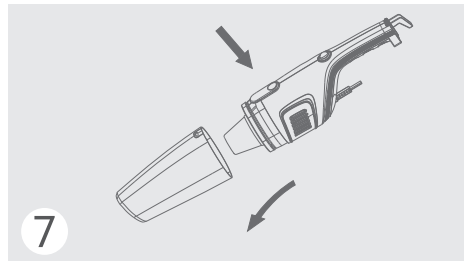

3. Rotate the ground brush slowly and firmly, and remove the ground brush after the ground brush is loosen.

4. Insert the brush nozzle into the suction inlet in the direction of the arrow as shown in Figure (4).

5. Insert the power plug into the socket and confirm that the connection is secure. Put the power switch of the machine body to „I” (ON) gear and the vacuum cleaner starts working.

6. Set the power switch to „O” (OFF) gear, and remove the plug from socket.

7. Press the dust panel frame switch, take the dust panel frame together with the strainer, and then take out the strainer to put the garbage in the dust panel frame into the waste container.

Product Parameters

Product name	Vacuum cleaner
Product model	DX118C
Rated voltage	220-240V~ 50-60Hz
Rated power	600W
Capacity	1.2L
Vacuum degree	≥15kPa
Noise	86dB

Packing List

Name	Quantity
Main machine	1
Ground brush	1
Flat suction mouth	1
Handle	1
Round brush	1
Manual	1
Warranty Card	1
Certificate	1

Fault Analysis and Troubleshooting

Note: Out off the power and unplug the power plug before troubleshooting.

The vacuum cleaner has a reduced suction force and an abnormal sound.

Troubleshooting: Stop working (overheated motor)

Blocked ground brush or suction

Troubleshooting: Dredge the attachments.

Blocked strainer

Troubleshooting: Clean or replace the strainer.

Vacuum cleaner motor does not work.

Troubleshooting: Check whether the plug is securely plugged into the outlet or the power is on.

The machine stopped working suddenly

Troubleshooting: Turn off the power switch, unplug the power plug, and after the vacuum cleaner has been cooled for 30 minutes, clean the garbage in the dust panel frame and reuse the machine.

If the problem persists, please contact our special maintenance department for maintenance.

Cleaning and Maintenance

Daily maintenance

Open the dust panel frame and take out the strainer, wash the strainer with water and let it dry naturally.

Precautions:

1. Clean the strainer at least once a month. When there is obvious accumulation on the strainer, clean it immediately. After washing, dry the strainer before use.
2. Operate the vacuum cleaner with the strainer installed.
3. Before using the vacuum cleaner again, be sure to check whether the strainer is installed or damaged.